

EFAPEL®

Empresa Fabril de Produtos Eléctricos, S.A.

TOMADA DE DADOS USB | VGA | RCA

TOMA DE DATOS USB | VGA | RCA

DATA SOCKET USB | VGA | RCA

PRISE DE DONNÉES USB | VGA | RCA

DATENSAMMLUNG USB | VGA | RCA

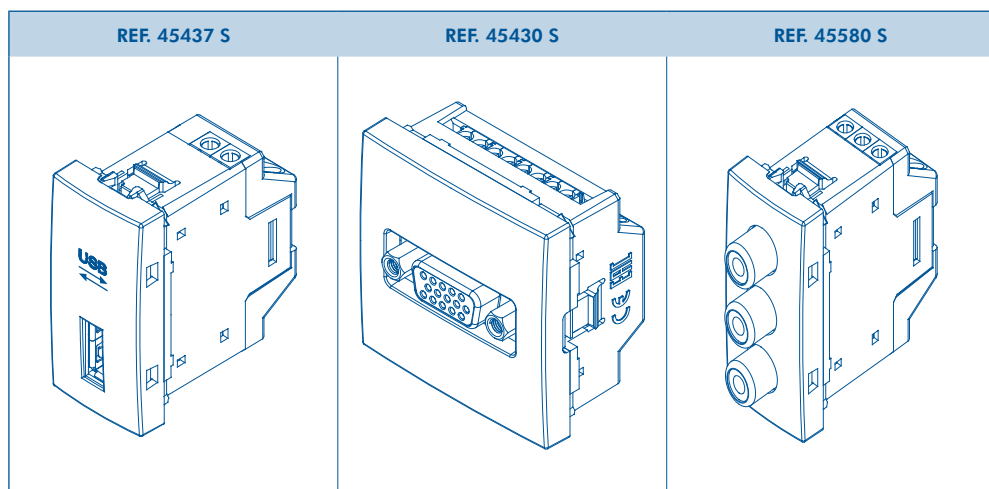

CARACTERÍSTICAS CARACTERÍSTICAS CHARACTERISTICS CARACTÉRISTIQUES EIGENSCHAFTEN			
	45437 S	45430 S	45580 S
Ligação Enlace Connection Connexion Verbindung	Parafuso Tornillo Screw Vis Schraube	Parafuso Tornillo Screw Vis Schraube	Parafuso Tornillo Screw Vis Schraube
Distância máxima entre tomadas Distancia máxima entre tomas Distance between HDMI sockets Distance maximale entre prises Abstand zwischen den HDMI-Buchsen	5 m	15 m	20 m
Velocidade máxima Velocidad maxima Maximum speed Vitesse de transfert maximale Maximale geschwindigkeit	12 Mbit/s	Não aplicável no aplicable not apply non applicable nicht zutreffend	Não aplicável no aplicable not apply non applicable nicht zutreffend
Mecanismos em termoplástico técnico - material resistente, não condutor. Mecanismos en termoplástico técnico - material resistente y no conductor. Mechanisms in technical thermoplastic - resistant material, non-conductive. Mécanismes en thermoplastique technique - matériel résistant, pas conducteur. Schaltgeräte aus widerstandsfähigen, thermoplastischem material, nicht leitend.			

mec 21

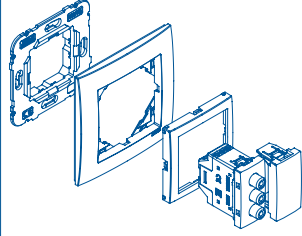
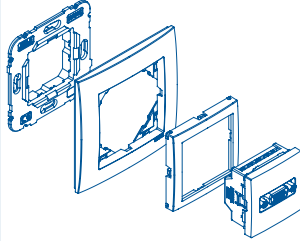
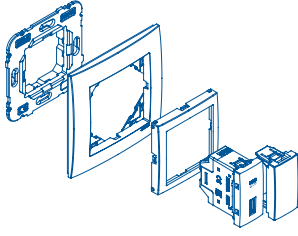

QUADRO 45

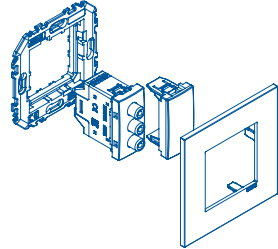
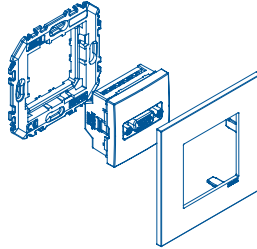
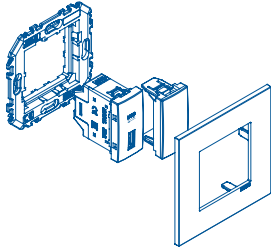

ESQUEMAS DE LIGAÇÃO | ESQUEMAS DE CONEXIÓN | WIRING DIAGRAMS | SCHÉMAS DE CONNEXION | SCHALTPLÄNE



Pin	
+	VBUS 5VDC
-	GROUND
D+	DATA +
D-	DATA -

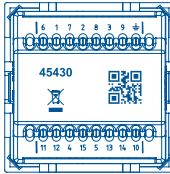
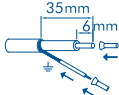
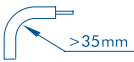

Pin	
1	RED COAX
2	GREEN COAX
3	BLUE COAX
4	ID BIT 2 - NC
5	RED (GND)
6	RED BRAID
7	GREEN BRAID
8	BLUE BRAID
9	WHITE (KEY)
10	BLUE (GND)
11	ID BIT 0 - GND
12	ID BIT 1 - SDA
13	HORIZONTAL SYNCHRONIZATION
14	VERTICAL SYNCHRONIZATION
15	ID BIT 3 - SCL
⊥	SHIELD (GROUND)



Pin	
V	VIDEO CABLE
R	RIGHT AUDIO SIGNALS
L	LEFT AUDIO SIGNALS
GND	GROUND

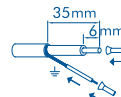
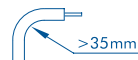

A EFAPEL reserva o direito de modificar este documento ou os produtos nele contidos sem aviso prévio. En caso de dúbida, por favor póngase en contacto con EFAPEL. EFAPEL se reserva el derecho de modificar este documento o los productos contenidos en él sin previo aviso. En caso de dudas, por favor póngase en contacto con EFAPEL. EFAPEL reserves the right to amend this document or the products contained in it without notice. In doubtful please contact EFAPEL. EFAPEL se réserve le droit de modifier ce document ou les produits ci-inclus sans préavis. En cas de doute, veuillez contacter EFAPEL. EFAPEL behält sich das Recht vor, dieses Dokument oder die darin enthaltenen Produkte zu ändern. Im Zweifelsfall kontaktieren Sie bitte EFAPEL.

